

STANDARD TRIACS

FEATURES

- $I_{T(RMS)} = 25A$
- $V_{DRM} = 400V$ to $800V$
- INSULATING VOLTAGE $2500V_{(RMS)}$
(UL RECOGNIZED : E81734)

DESCRIPTION

The T25xxxKS series triacs uses a high performance MESA GLASS technology. These parts are intended for general purpose switching and phase control applications.

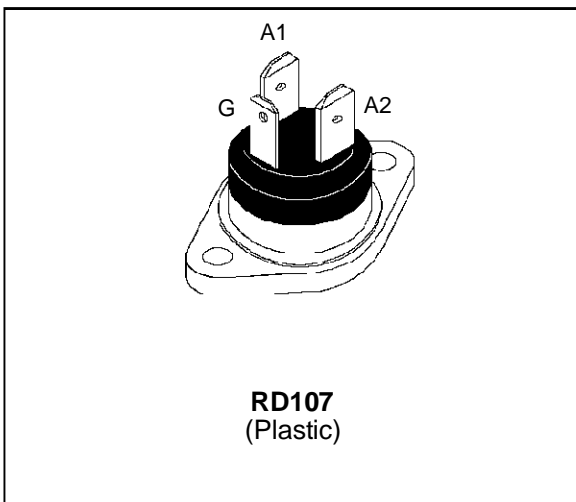

ABSOLUTE RATINGS (limiting values)

Symbol	Parameter		Value	Unit
$I_{T(RMS)}$	RMS on-state current (360° conduction angle)	$T_c = 85^\circ C$	25	A
I_{TSM}	Non repetitive surge peak on-state current (T_j initial = $25^\circ C$)	$t_p = 8.3$ ms	260	A
		$t_p = 10$ ms	250	
I^2t	I^2t Value for fusing	$t_p = 10$ ms	312	A^2s
di/dt	Critical rate of rise of on-state current $I_G = 500$ mA $di_G/dt = 1$ A/ μs .	Repetitive F = 50 Hz	10	A/ μs
		Non Repetitive	50	
T_{stg} T_j	Storage and operating junction temperature range		- 40, + 150 - 40, + 125	$^\circ C$
TI	Maximum lead temperature for soldering during 10s		260	$^\circ C$

Symbol	Parameter	Voltage				Unit
		D	M	S	N	
V_{DRM} V_{RRM}	Repetitive peak off-state voltage $T_j = 125^\circ C$	400	600	700	800	V

T25xxxKS

THERMAL RESISTANCES

Symbol	Parameter	Value	Unit
Rth(j-c)	Junction to case for D.C	1.7	°C/W
Rth(j-c)	Junction to case for A.C 360° conduction angle (F=50Hz)	1.3	°C/W

GATE CHARACTERISTICS (maximum values)

$P_{G(AV)} = 1 \text{ W}$ $P_{GM} = 10 \text{ W}$ ($t_p = 20 \mu\text{s}$) $I_{GM} = 4 \text{ A}$ ($t_p = 20 \mu\text{s}$)

ELECTRICAL CHARACTERISTICS

Symbol	Test Conditions		Quadrant		Sensitivity		Unit
					12	13	
I_{GT}	$V_D = 12\text{V (DC)}$ $R_L = 33\Omega$	$T_j = 25^\circ\text{C}$	I-II-III	MAX	50	50	mA
			IV	MAX	50	75	
V_{GT}	$V_D = 12\text{V (DC)}$ $R_L = 33\Omega$	$T_j = 25^\circ\text{C}$	I-II-III-IV	MAX	1.5		V
V_{GD}	$V_D = V_{DRM}$ $R_L = 3.3\text{k}\Omega$	$T_j = 125^\circ\text{C}$	I-II-III-IV	MIN	0.2		V
tgt	$V_D = V_{DRM}$ $I_G = 500\text{mA}$ $I_T = 35\text{A}$ $di_G/dt = 3\text{A}/\mu\text{s}$	$T_j = 25^\circ\text{C}$	I-II-III-IV	TYP	2		μs
I_H^*	$I_T = 250 \text{ mA}$ Gate open	$T_j = 25^\circ\text{C}$		MAX	50	75	mA
I_L	$I_G = 1.2 I_{GT}$	$T_j = 25^\circ\text{C}$	I-III-IV	TYP	50	75	mA
			II	TYP	100	150	
V_{TM}^*	$I_{TM} = 35\text{A}$ $t_p = 380\mu\text{s}$	$T_j = 25^\circ\text{C}$		MAX	1.5		V
I_{DRM} I_{RRM}	$V_D = V_{DRM}$ $V_R = V_{RRM}$	$T_j = 25^\circ\text{C}$		MAX	10		μA
		$T_j = 125^\circ\text{C}$		MAX	3		mA
dV/dt *	$V_D = 67\% V_{DRM}$ Gate open	$T_j = 125^\circ\text{C}$		MIN	500		V/ μs
(dV/dt)c *	(di/dt)c = 11 A/ms	$T_j = 125^\circ\text{C}$		MIN	5		V/ μs

* For either polarity of electrode A₂ voltage with reference to electrode A₁

ORDERING INFORMATION

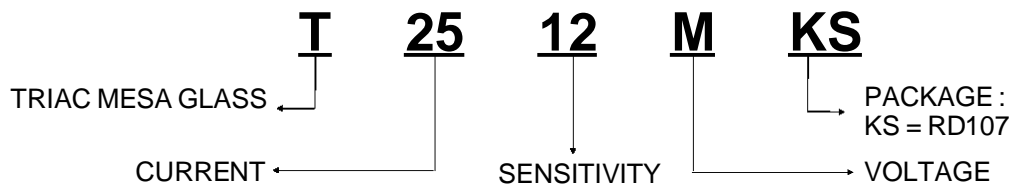

Fig.1 : Maximum RMS power dissipation versus RMS on-state current.

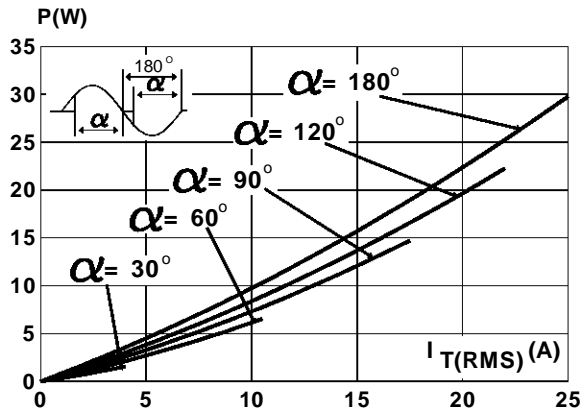

Fig.2 : Correlation between maximum RMS power dissipation and maximum allowable temperature (Tamb and Tcase) for different thermal resistances heatsink + contact.

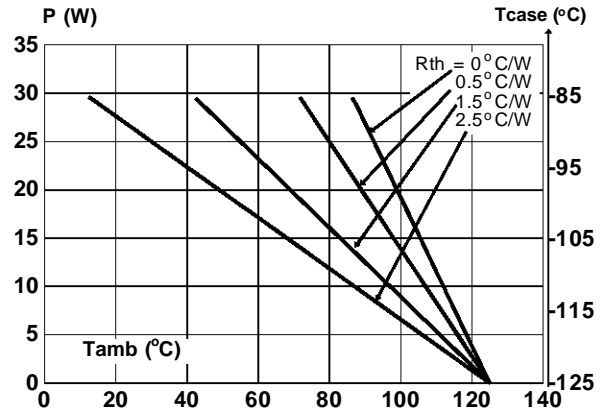

Fig.3 : RMS on-state current versus case temperature.

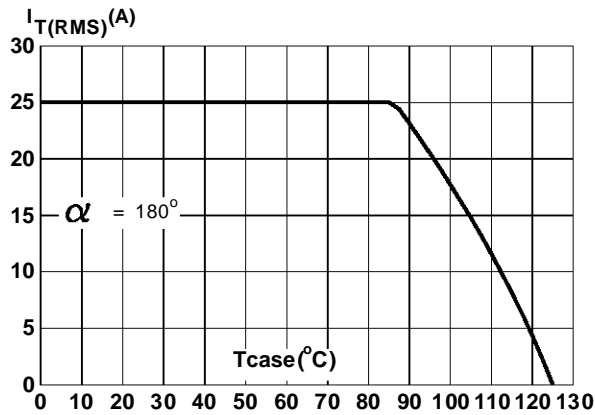

Fig.4 : Relative variation of thermal impedance junction to case versus pulse duration.

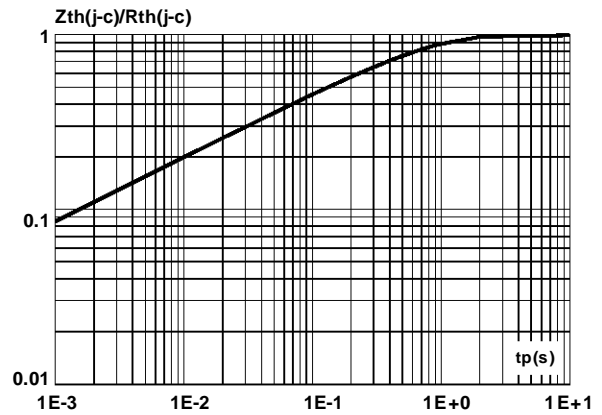

Fig.5 : Relative variation of gate trigger current and holding current versus junction temperature.

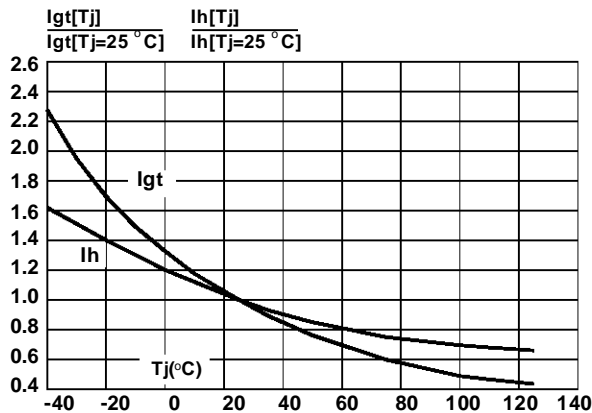
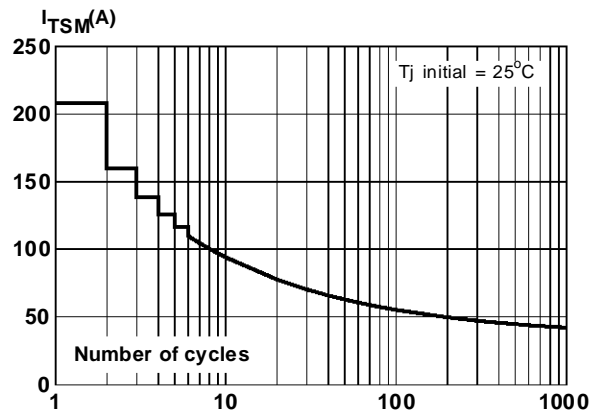

Fig.6 : Non repetitive surge peak on-state current versus number of cycles.



T25xxxKS

Fig.7 : Non repetitive surge peak on-state current for a sinusoidal pulse with width : $t_p \leq 10\text{ms}$, and corresponding value of I^2t .

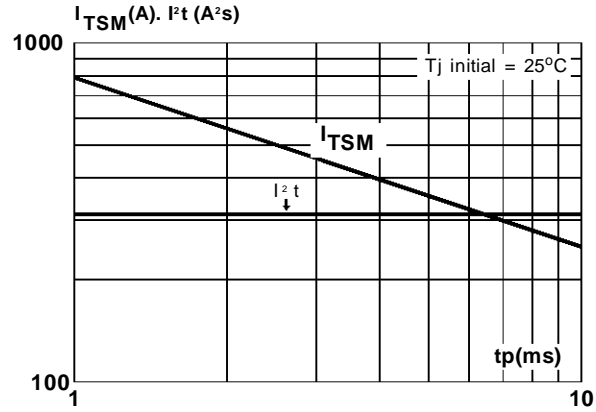
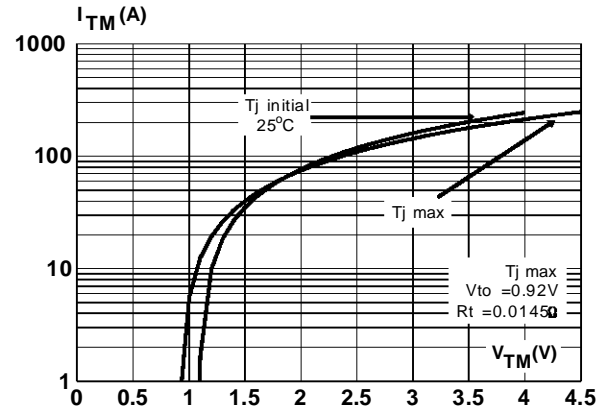
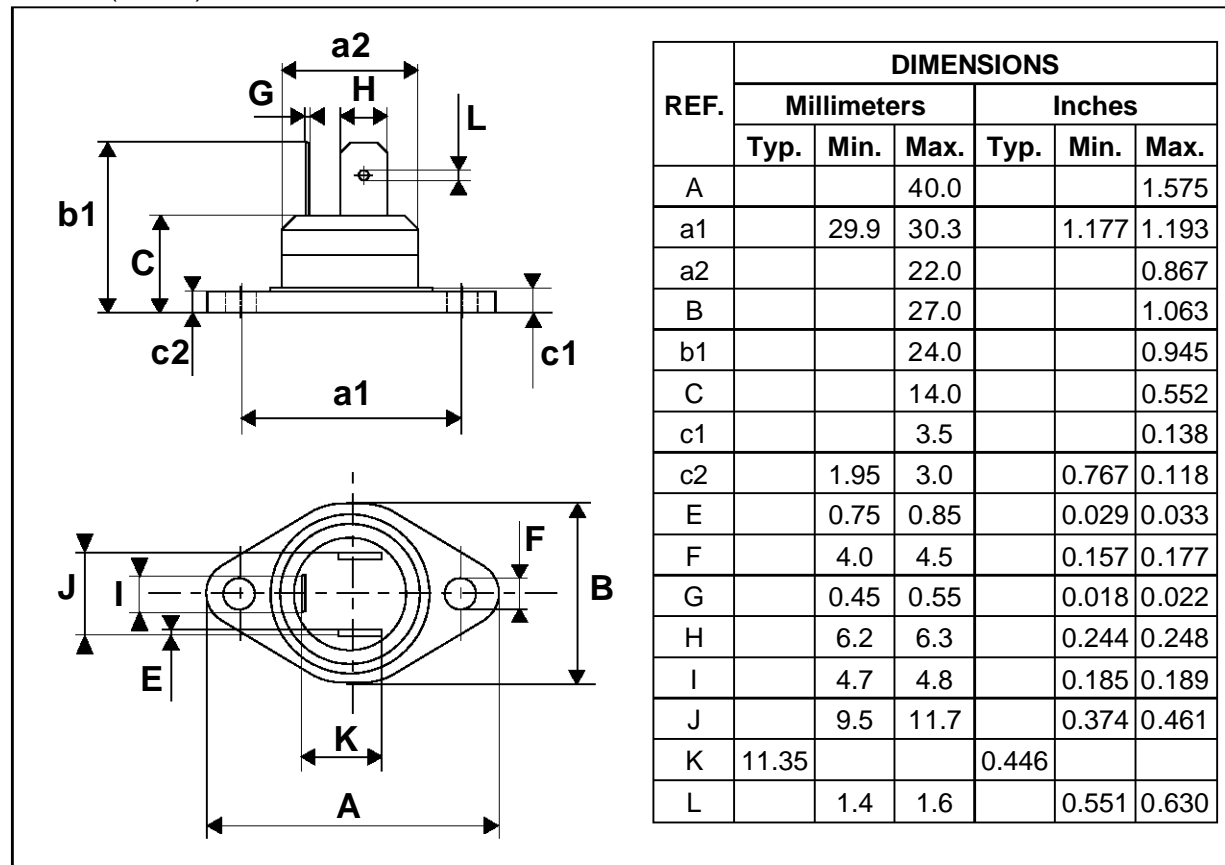

Fig.8 : On-state characteristics (maximum values).



PACKAGE MECHANICAL DATA
RD107 (Plastic)



Marking : type number
Weight : 20 g

Information furnished is believed to be accurate and reliable. However, SGS-THOMSON Microelectronics assumes no responsibility for the consequences of use of such information nor for any infringement of patents or other rights of third parties which may result from its use. No license is granted by implication or otherwise under any patent or patent rights of SGS-THOMSON Microelectronics. Specifications mentioned in this publication are subject to change without notice. This publication supersedes and replaces all information previously supplied. SGS-THOMSON Microelectronics products are not authorized for use as critical components in life support devices or systems without express written approval of SGS-THOMSON Microelectronics.

© 1995 SGS-THOMSON Microelectronics - All rights reserved.

SGS-THOMSON Microelectronics GROUP OF COMPANIES

Australia - Brazil - France - Germany - Hong Kong - Italy - Japan - Korea - Malaysia - Malta - Morocco - The Netherlands
Singapore - Spain - Sweden - Switzerland - Taiwan - Thailand - United Kingdom - U.S.A.